



FLOW RATE INDICATOR / TOTALIZER

WITH ANALOG AND PULSE SIGNAL OUTPUTS



Features

- Displays instantaneous flow rate, total and accumulated total.
- Large 17mm (0.67") digit selection for flow rate or total.
- Selectable on-screen engineering units; volumetric or mass.
- Ability to process all types of flowmeter signals.
- Auto backup of settings and running totals.
- Operational temperature -30°C up to +80°C (-22°F up to 178°F).
- Very compact design for panel mount, wall mount or field mount applications.
- Rugged aluminum field mount enclosure IP67/NEMA4X.
- Intrinsically Safe
 -  II 1 GD EEx ia IIB/IIC T4 T100°C.
- Explosion/flame proof  II 2 GD EEx d IIB T5.
- Analog and pulse signal outputs.
- Full Modbus communication RS232/485/TTL.
- Loop or battery powered, 8 - 24V AC/DC or 115 - 230V AC power supply.
- Sensor supply 3.2 - 8.2 - 12 - 24V DC.

Signal output

- (0)4 - 20mA / 0 - 10V DC according to flow rate.
- Scaled pulse output according to accumulated total.

Signal input

Flow

- Reed-switch.
- NAMUR.
- NPN/PNP pulse.
- Sine wave (coil).
- Active pulse signals.
- (0)4 - 20mA.
- 0 - 10V DC.

Applications

- Liquid flow measurement where re-transmission of the flow rate and/or totalizer functions or serial communication is required. Alternative basic models: F010 - F011 - F012 - F014 or more advanced F112 - F113 - F118.

General information

Introduction

The F110 is the most popular model in our range of flow rate / totalizers, complete with pulse and analog output signals. Even demanding applications are catered for with our base unit configuration. A wide selection of options further enhance this models capabilities, including Intrinsic Safety and full Modbus communication.

Display

The display has large 17mm (0.67") and 8mm (0.31") digits which can be set to show flow rate and totals. On-screen engineering units are easily configured from a comprehensive selection. The accumulated total can register up to 11 digits and is backed-up in EEPROM memory every minute.

Configuration

All configuration settings are accessed via a simple operator menu which can be pass-code protected. Each setting is clearly indicated with an alphanumerical description, therefore avoiding confusing abbreviations and baffling codes. Once familiar with one F-series product, you will be able to program all models in the series without a manual. All settings are safely stored in EEPROM memory in the event of sudden power failure.

Analog output signal

The flow rate is re-transmitted with the (0)4 - 20mA or 0 - 10V DC output signal.

The output signal is updated ten times per second with a filter function being available to smoothen out the signal if desired.

The output value is user defined in relation to the flow rate, e.g. 4mA equals to 15L/Hr and 20mA equals to 2000L/Hr. The output signal can be passive, active or isolated where the passive output type will loop power the F110 as well.

Pulse output

The scaleable pulse output, reflects the count on the accumulated display. The pulse length is user defined from 0.008 second up to 2 seconds. The maximum output frequency is 64Hz. The output signal can be a passive NPN, active PNP or an isolated electro-mechanical relay.

Signal input

The F110 will accept most pulse and analog input signals for flow or mass flow measurement. The input signal type can be selected by the user in the configuration menu without having to adjust any sensitive mechanical dip-switches or jumpers. The analog input versions are even available as 4-20mA input loop powered displays.

Communication

All process data and settings can be read and modified manually or through the Modbus communication link (RS232 / RS485).

Full Modbus functionality remains available for the Intrinsically Safe version (TTL).

Hazardous areas

For hazardous area applications, this model has been ATEX certified Intrinsically Safe $\text{Ex II 1 GD EEx ia IIB / IIC T4 T100}^\circ\text{C}$ with an allowed operational temperature of -30°C to $+70^\circ\text{C}$ (-22°F to $+158^\circ\text{F}$). A flame proof enclosure is also available with the rating $\text{Ex II 2 GD EEx d IIB T5}$.

Enclosures

Various types of enclosures can be selected, all ATEX approved. As standard the F110 is supplied in an GRP panel mount enclosure, which can be converted to an IP67 / NEMA 4X GRP field mount enclosure by the addition of a back case. Most popular is our rugged aluminum field mount enclosure with IP67 / NEMA 4X rating. Both European or U.S. cable gland entry threads are available.

Overview application F110

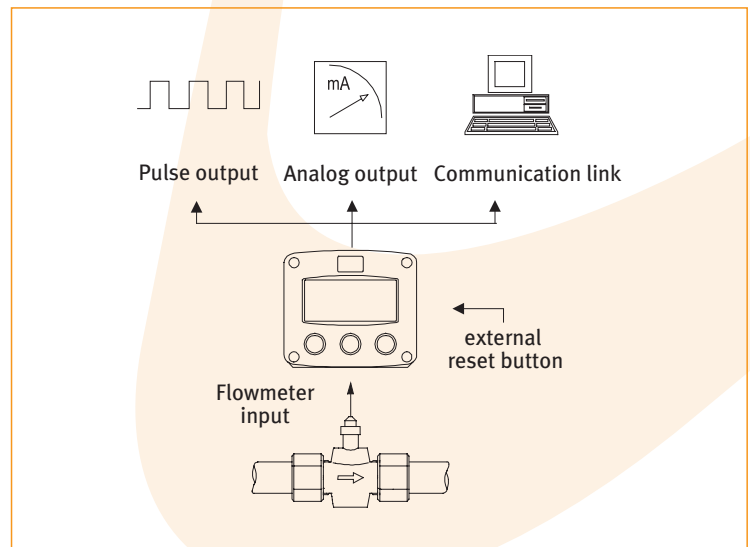

Dimensions enclosures

Aluminum & GRP panel mount enclosure

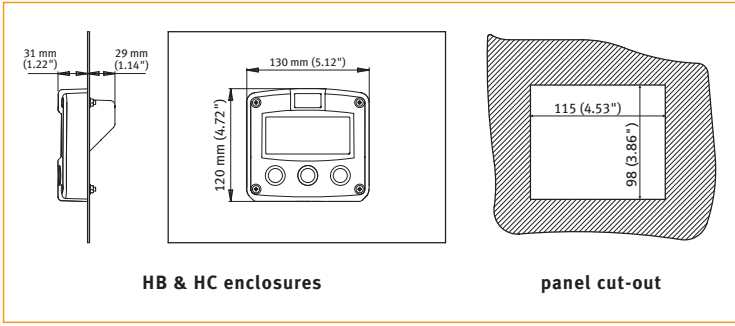

Aluminum & GRP field / wall mount enclosures

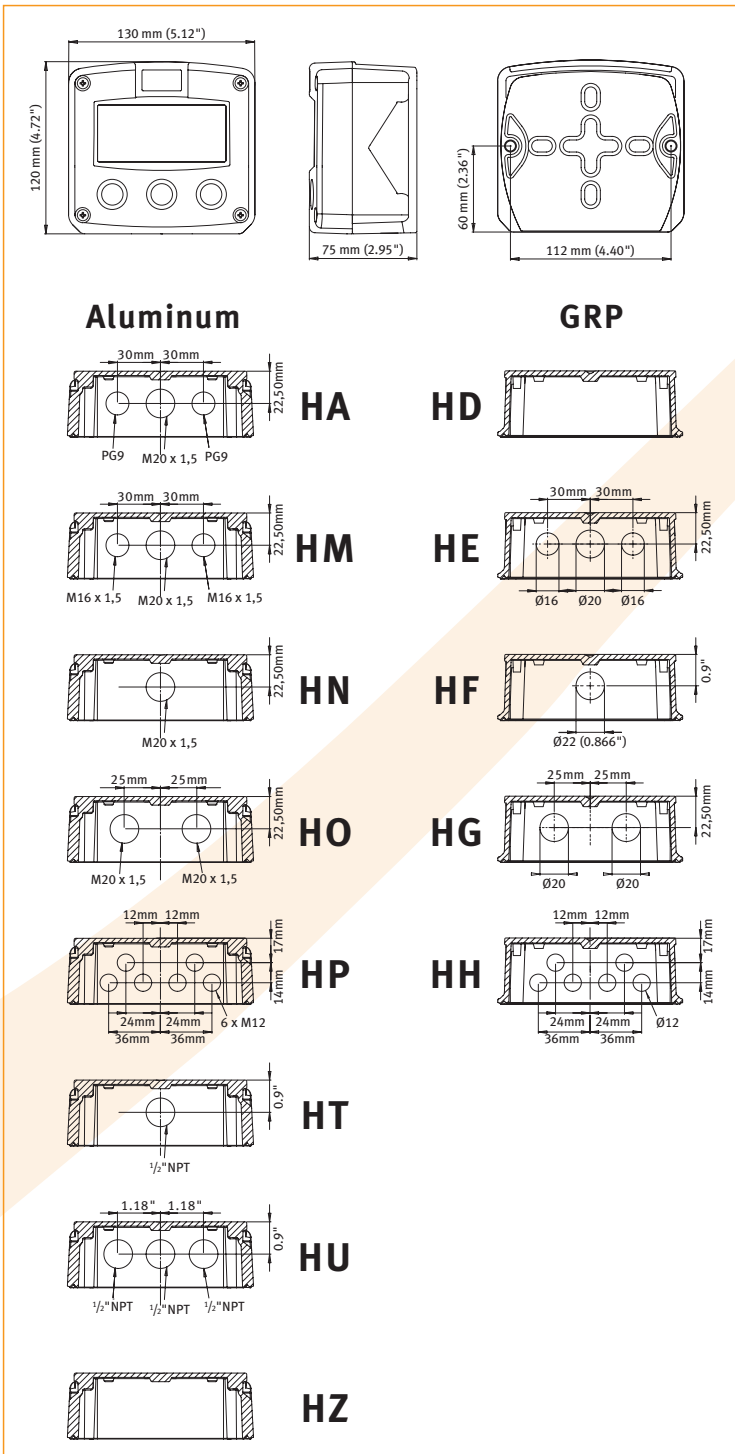

Terminal connections

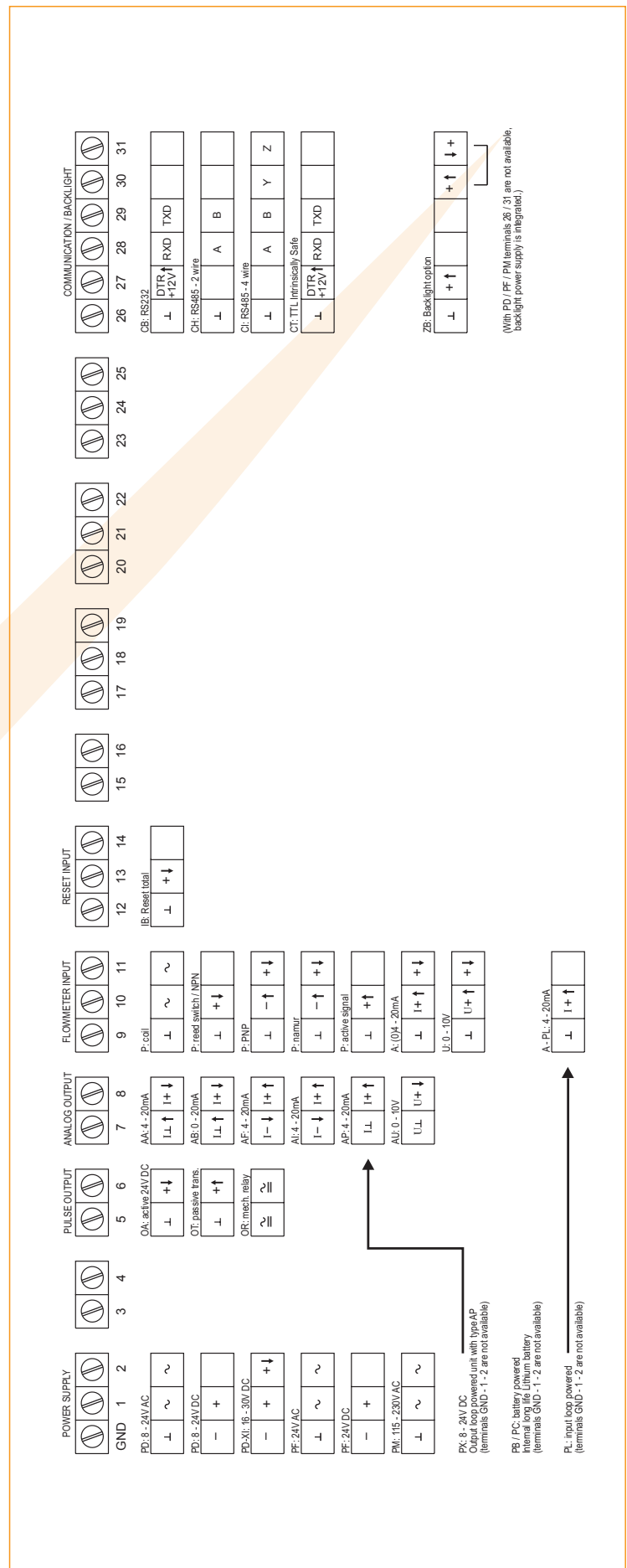

Typical wiring diagram F110-P-(AP)-CH-IB-OT-PB

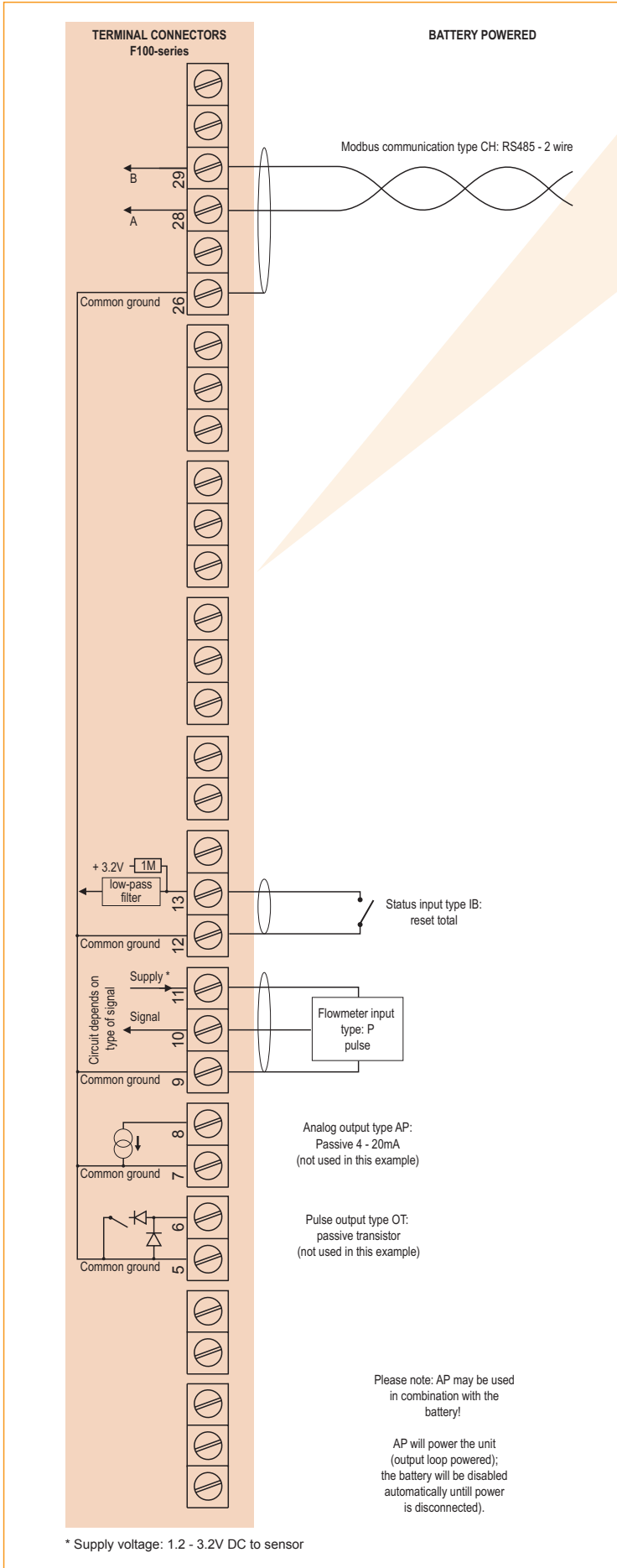

Typical wiring diagram F110-P-AP-CH-IB-OT-PX

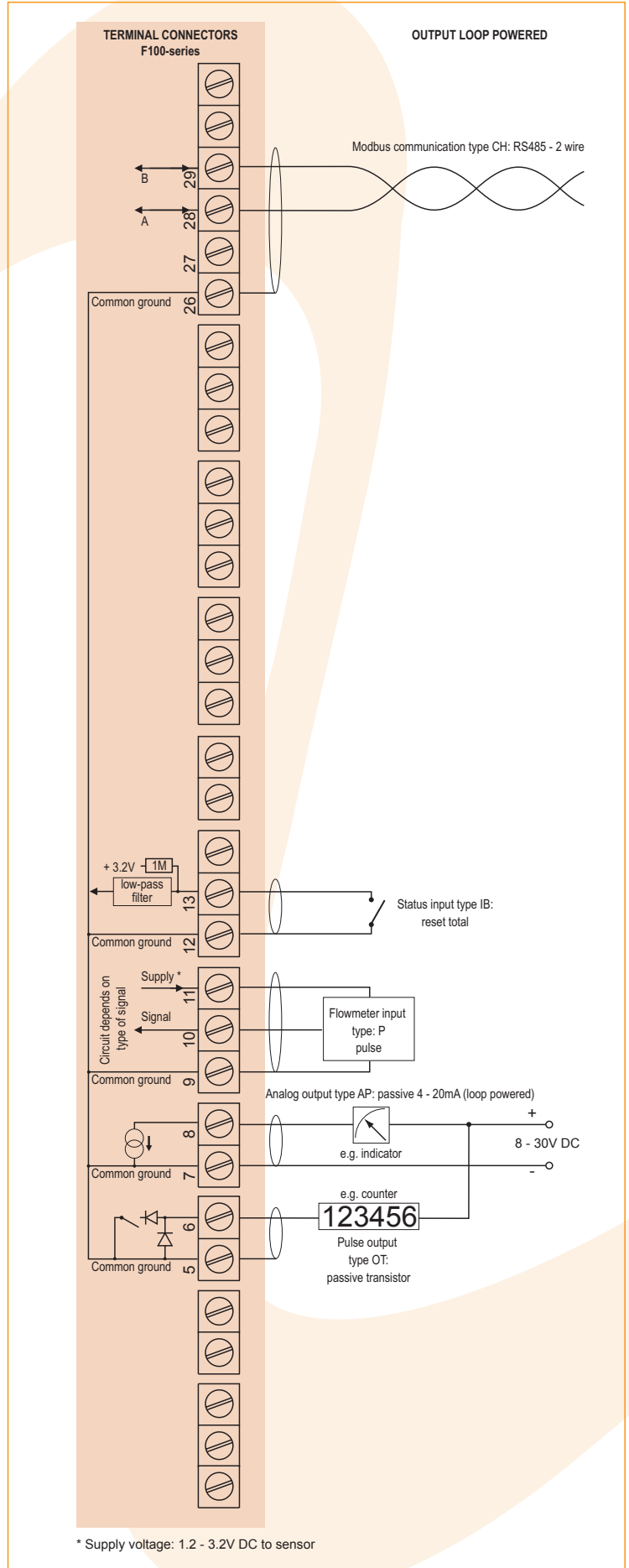

Typical wiring diagram F110-A-AA-CB-IB-OA-PD

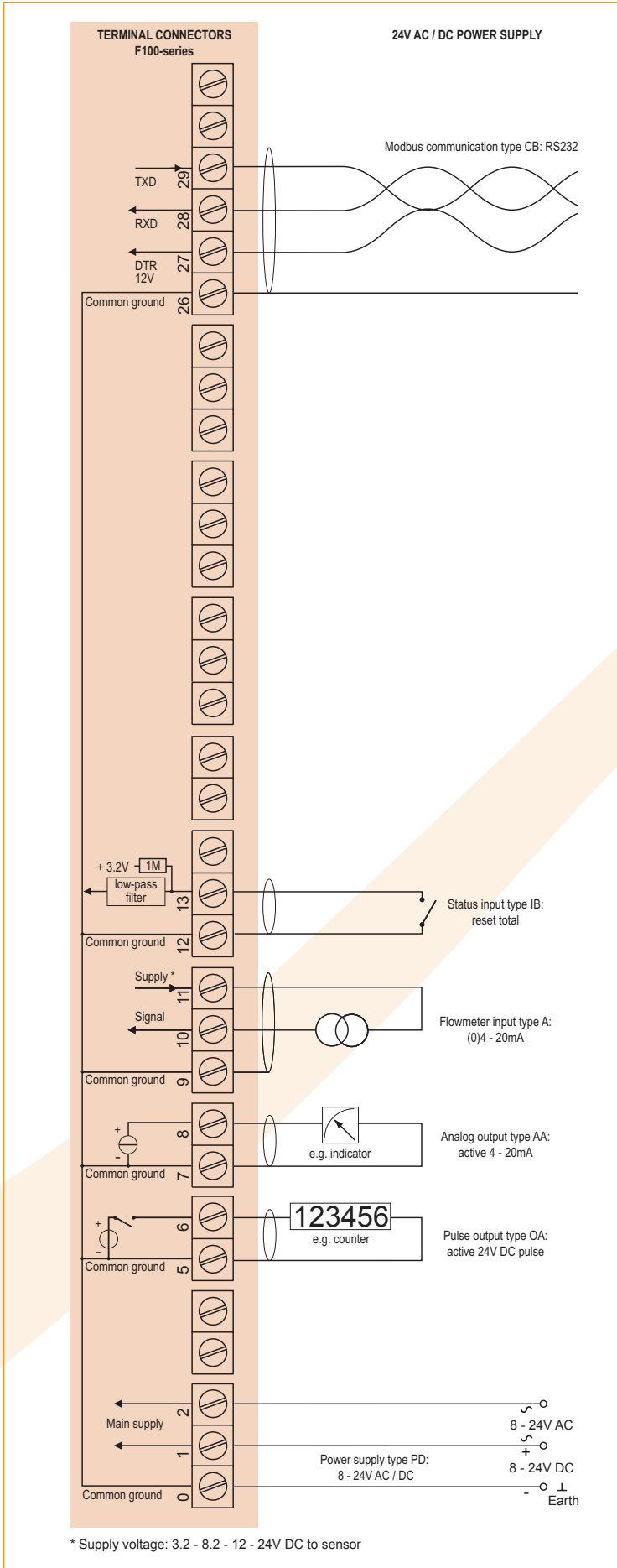

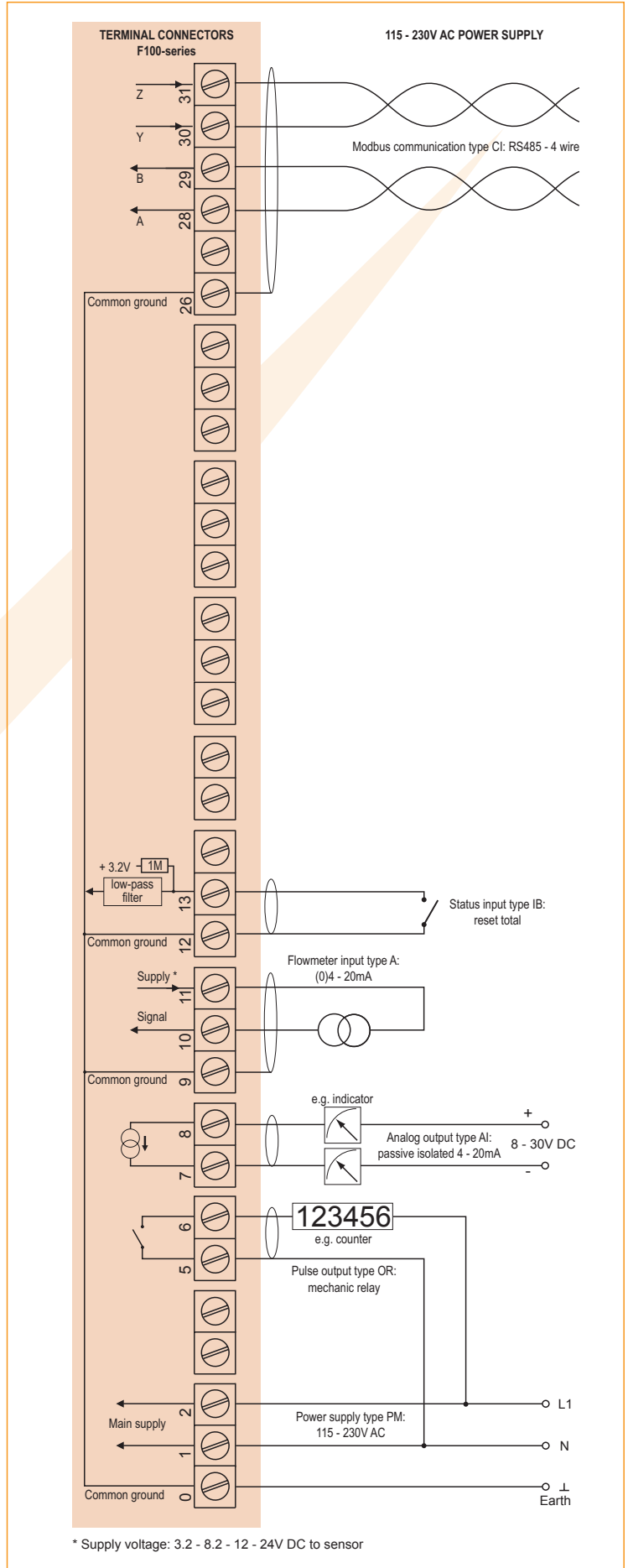

Typical wiring diagram F110-A-AI-CI-IB-OR-PM



Hazardous area applications

The F110-XI has been ATEX approved by KEMA for use in Intrinsically Safe applications. It is approved according to Ex II 1 GD EEx ia IIB/IIC T4 T100°C for gas and dust applications with an operational temperature range of -30°C to +70°C (-22°F to +158°F). Besides the I.S. power supply for the pulse output, it is allowed to connect up to three I.S. power supplies in IIB applications or one in IIC applications. Full functionality of the F110 remains available, including 4 - 20mA output, pulse output and Modbus communication (type CT). Power supply type PD-XI offers a 8.2V sensor supply e.g. for one Namur sensor. A flame proof enclosure with rating Ex II 2 GD EEx d IIB T5 is available as well. Please contact your supplier for further details.

Certificate of conformity KEMA 03ATEX1074 X

(1) **EC-TYPE EXAMINATION CERTIFICATE**

(2) Equipment or protective system intended for use in potentially explosive atmospheres – Directive 94/9/EC

(3) EC-Type Examination Certificate Number: KEMA 03ATEX1074 X

(4) Equipment or protective system: Indicator Model F100 Series

(5) Manufacturer: Fluidwell B.V.

(6) Address: Eisenhowerweg 1, 5466 AB Veghel, The Netherlands

(7) This equipment or protective system and any acceptable variation thereto is specified in the schedule to this certificate and the documents therein referred to.

(8) KEMA Quality B.V., notified body number 0344 in accordance with Article 9 of the Council Directive 94/9/EC of 23 March 1994, certifies that this equipment or protective system has been found to comply with the Essential Health and Safety Requirements relating to the design and construction of equipment and protective systems intended for use in potentially explosive atmospheres given in Annex II to the Directive.

The examination and test results are recorded in confidential report no. 2028528.

(9) Compliance with the Essential Health and Safety Requirements has been assured by compliance with:

EN 50014 : 1997 EN 50020 : 2002 EN 50281-1-1 : 1998 EN 50284 : 1999

(10) If the sign "X" is placed after the certificate number, it indicates that the equipment or protective system is subject to special conditions for safe use specified in the schedule to this certificate.

(11) This EC-Type Examination Certificate relates only to the design, examination and tests of the specified equipment or protective system according to the Directive 94/9/EC. Further requirements of the Directive apply to the manufacturing process and supply of this equipment or protective system. These are not covered by this certificate.

(12) The marking of the equipment or protective system shall include the following:

Ex II 1 GD EEx ia IIB/IIC T4 T 100 °C

Amham, 2 July 2003
KEMA Quality B.V.

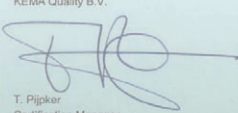

T. Pijker
Certification Manager

* This Certificate may only be reproduced in its entirety and without any change

KEMA Quality B.V.
Utrechtseweg 310, 6812 AR Amham, The Netherlands
P.O. Box 5165, 6802 ED Amham, The Netherlands
Telephone +31 26 3 56 20 08, Telefax +31 26 3 52 58 00

ACCREDITED BY THE
DUTCH ACCREDITATION
COUNCIL

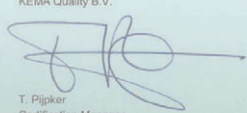

Page 1/8

Configuration example IIB and IIC

F110-P-(AP)-(CT)-IB-(OT)-PC-XI - Battery powered unit

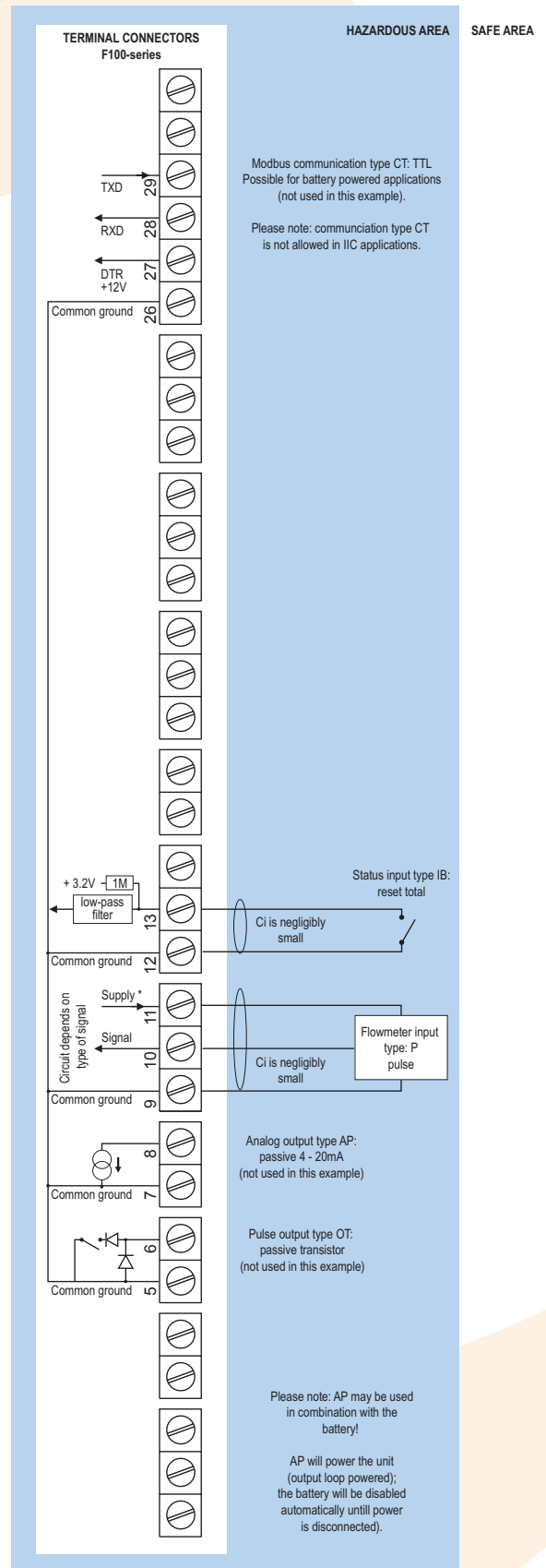

* Note sensor supply voltage: 1.2V DC for coil sensors or 3.2V DC for other pulse sensors.

Configuration example IIB and IIC - F110-P-AP-(CT)-IB-OT-PX-XI - Output loop powered

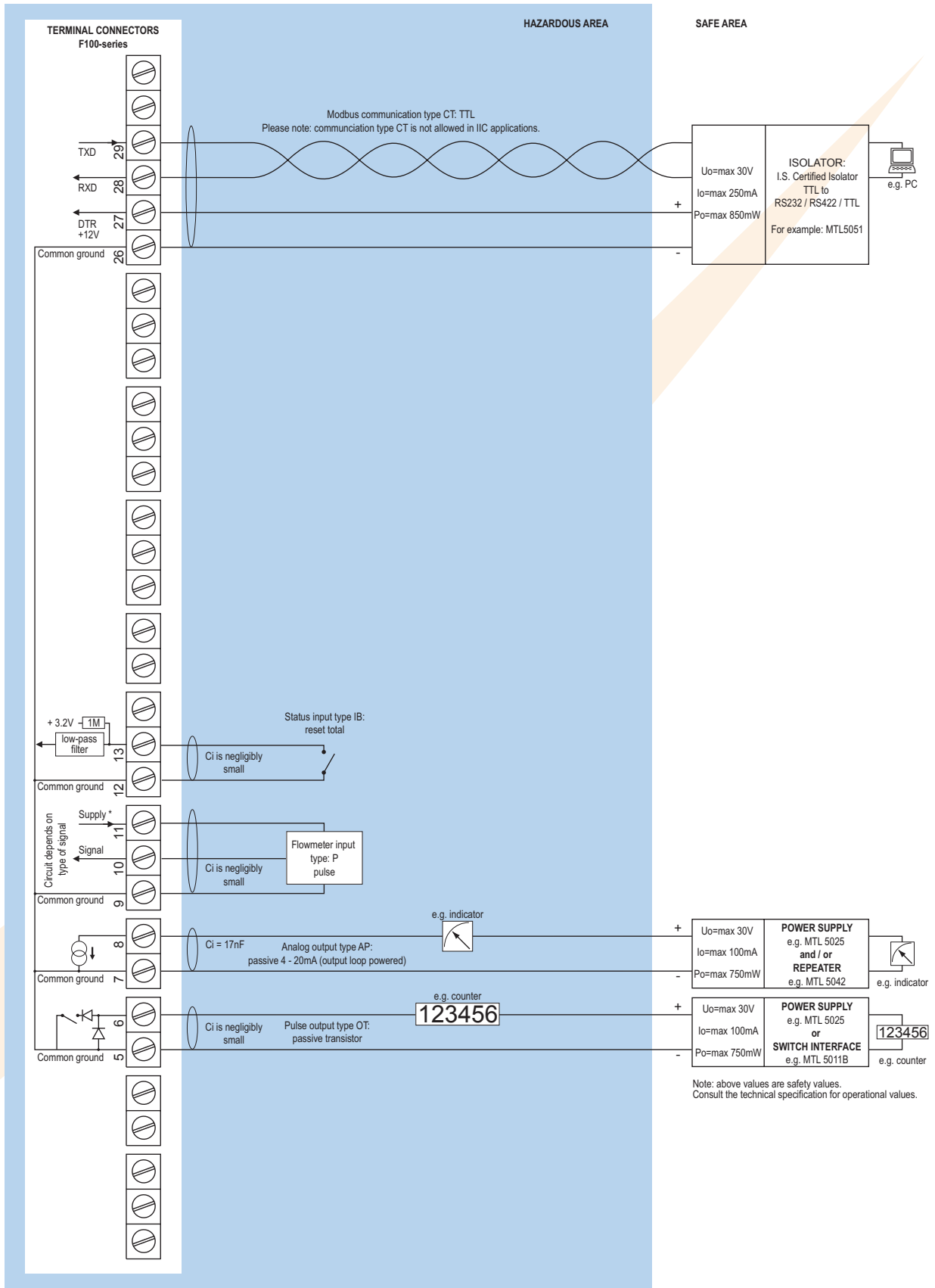

* Note sensor supply voltage: 1.2V DC for coil sensors or 3.2V DC for other pulse sensors.

Configuration example IIB and IIC - F110-A-AF-(CT)-IB-OT-PD-XI - Power supply 16 - 30V DC

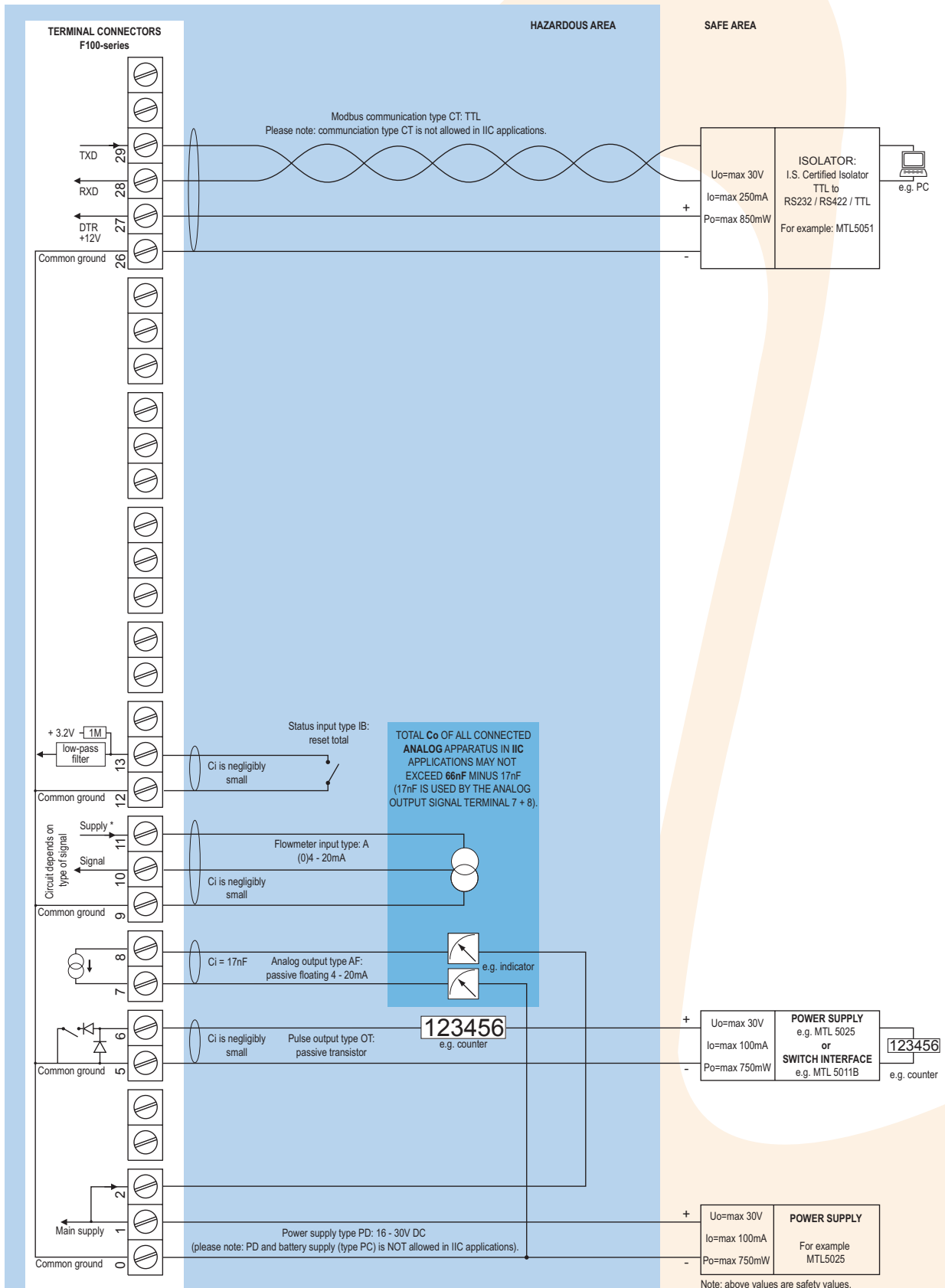

* Note power supply type PD: the supply voltage to pulse sensors is maximum 8.7V (Uo=max 8.7V Io=max 25mA Po=max 150mW) and to analog sensors as connected to terminal 1 (internally linked).

Configuration example IIB - F110-A-AF-CT-IB-OT-(PC)-(PD)-(PL)-XI - Power supply 16 - 30V DC, battery or loop powered

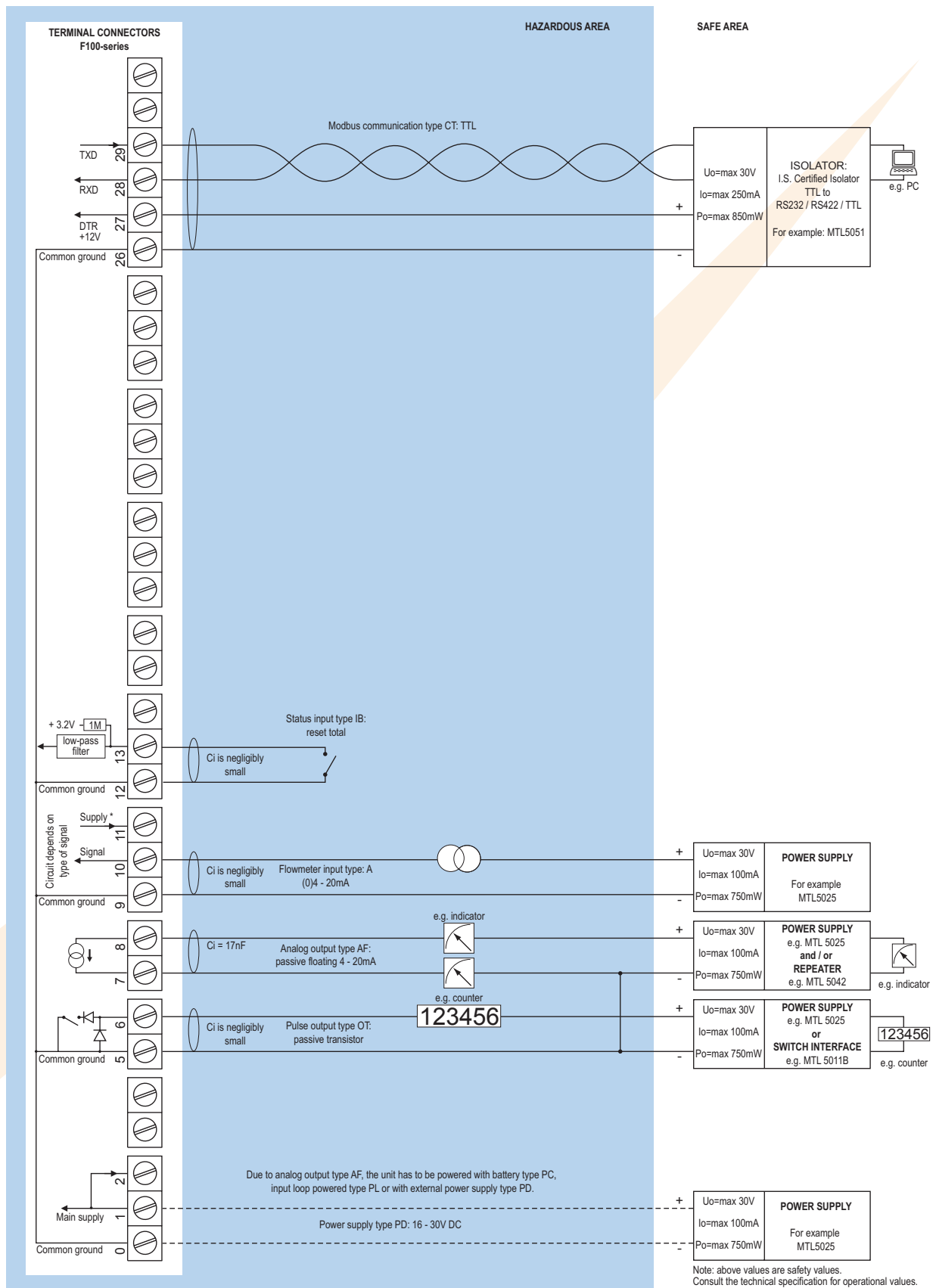

Technical specification

General

Display	
Type	High intensity reflective numeric and alphanumeric LCD, UV-resistant.
Dimensions	90 x 40mm (3.5" x 1.6").
Digits	Seven 17mm (0.67") and eleven 8mm (0.31") digits. Various symbols and measuring units.
Refresh rate	User definable: 8 times/sec. - 30 secs.
Option ZB	Transflective LCD with green LED backlight. Good readings in full sunlight and darkness.
Note	Only available for safe area applications.

Operating temperature

Operational	-30°C to +80°C (-22°F to +178°F).
Intrinsically Safe	-30°C to +70°C (-22°F to +158°F).

Power requirements

Type PB	Long life Lithium battery - life-time depends upon settings and configuration - up to 5 years.
Type PC	Intrinsically Safe long life lithium battery - life-time depends upon settings and configuration - up to 5 years.
Type PD	8 - 24V AC / DC ± 10%. Power consumption max. 10 Watt. Intrinsically Safe: 16 - 30V DC; power consumption max. 0.75 Watt.
Type PF	24V AC / DC ± 10%. Power consumption max. 15 Watt.
Type PL	Input loop powered from sensor signal 4 - 20mA (type "A") - requires types AI or AF and OT.
Type PM	115 - 230V AC ± 10%. Power consumption max. 15 Watt.
Type PX	8 - 30V DC. Power consumption max. 0.5 Watt.
Type ZB	12 - 24V DC ± 10% or type PD / PF / PM. Power consumption max. 1 Watt.
Note PB/PF/PM	Not available Intrinsically Safe.
Note PF/PM	The total consumption of the sensors and outputs may not exceed 400mA @ 24V.
Note	For Intrinsically Safe applications, consult the safety values in the certificate.

Sensor excitation

Type PB/PC/PX	3.2V DC for pulse signals and 1.2V DC for coil pick-up.
Note	This is not a real sensor supply. Only suitable for sensors with a very low power consumption like coils (sine wave) and reed-switches.
Type PD	1.2 - 3.2 - 8.2 - 12 and 24V DC - max. 50mA @ 24V DC.
Type PD-XI	1.2 - 3.2 - 8.2V DC - max. 7mA @ 8.2V DC and mains power supply voltage (as connected to terminal 1).
Note	In case PD-XI and signal A or U: the sensor supply voltage is according to the power supply voltage connected to terminal 1. Also terminal 2 offers the same voltage.
Type PF / PM	1.2 - 3.2 - 8.2 - 12 and 24V DC - max. 400mA @ 24V DC.



Terminal connections

Type	Removable plug-in terminal strip. Wire max. 1.5mm ² and 2.5mm ² .
------	-----------------------------------------------------------------------------------------

Data protection

Type	EEPROM backup of all settings. Backup of running totals every minute. Data retention at least 10 years.
Pass-code	Configuration settings can be pass-code protected.

Hazardous area

Intrinsically Safe	ATEX approval ref.:  II 1 GD EEx ia IIB/IIC T4 T100°C.
Type XI	Maximum ambient +70°C (158°F).
Explosion proof	ATEX approval ref.:  II 2 GD EEx d IIB T5.
Type XF	Dimensions of enclosure: 300 x 250 x 200mm (11.8" x 9.9" x 7.9") L x H x D.
Weight	appr. 15 Kg.

Environment

Electromagnetic compatibility	Compliant ref: EN 61326 (1997), EN 61010-1 (1993).
-------------------------------	----------------------------------------------------

Casing

General

Window	Polycarbonate window.
Sealing	Silicone.
Control keys	Three industrial micro-switch keys. UV-resistant silicone keypad.
Option ZS	Silicone free ABS enclosure with EPDM and PE sealings. UV-resistant polyester keypad.
Note	This option comes with type HD only.

Aluminum wall / field mount enclosures

General	Die-cast aluminum wall/field mount enclosure IP67 / NEMA 4X with 2-component UV-resistant coating.
Dimensions	130 x 120 x 75mm (5.12" x 4.72" x 2.95") - W x H x D.
Weight	1064 gr.
Type HA	Cable entry: 2 x PG9 and 1 x M20.
Type HM	Cable entry: 2 x M16 and 1 x M20.
Type HN	Cable entry: 1 x M20.
Type HO	Cable entry: 2 x M20.
Type HP	Cable entry: 6 x M12.
Type HT	Cable entry: 1 x 1/2" NPT.
Type HU	Cable entry: 3 x 1/2" NPT.
Type HZ	Cable entry: no holes.

GRP wall / field mount enclosures

General	GRP wall/field mount enclosure IP67 / NEMA 4X, UV-resistant and flame retardant.
Dimensions	130 x 120 x 75mm (5.12" x 4.72" x 2.95") - W x H x D.
Weight	566 gr.
Type HD	Cable entry: no holes.
Type HE	Cable entry: 2 x Ø 16mm and 1 x Ø 20mm.
Type HF	Cable entry: 1 x Ø 22mm (0.866").
Type HG	Cable entry: 2 x Ø 20mm.
Type HH	Cable entry: 6 x Ø 12mm.

Panel mount enclosures

Dimensions	130 x 120 x 60mm (5.12" x 4.72" x 2.36") - W x H x D.
Panel cut-out	115 x 98mm (4.53" x 3.86") L x H.
Type HB	Die-cast aluminum panel mount enclosure IP65 / NEMA 4.
Weight	570 gr.
Type HC	GRP panel mount enclosure IP65 / NEMA 4, UV-resistant and flame retardant.
Weight	422 gr.

Signal inputs

Flowmeter

Type P	Coil / sine wave (minimum 20mVpp or 80mVpp - sensitivity selectable), NPN/PNP, open collector, reed-switch, Namur, active pulse signals 8 - 12 and 24V DC.
Frequency	Minimum 0Hz - maximum 7kHz for total and flow rate. Maximum frequency depends on signal type and internal low-pass filter. E.g. reed switch with low-pass filter: max. frequency 120Hz.
K-Factor	0.000010 - 9,999,999 with variable decimal position.
Low-pass filter	Available for all pulse signals.
Option ZF	coil sensitivity 10mVpp.
Type A	(0)4 - 20mA. Analog input signal can be scaled to any desired range within 0 - 20mA.
Type U	0 - 10V DC. Analog input signal can be scaled to any desired range within 0 - 10V DC.
Accuracy	Resolution: 14 bit. Error < 0.025mA / \pm 0.125% FS. Low level cut-off programmable.
Span	0.000010 - 9,999,999 with variable decimal position.
Update time	Four times per second.
Voltage drop	Type A: 2.5V @ 20mA.
Load impedance	Type U: 3k Ω .
Relationship	Linear and square root calculation.
Note	For signal type A and U: external power to sensor is required; e.g. type PD.

Logic inputs

Function	Terminal input to reset total remotely.
Type IB	Internally pulled-up switch contact - NPN.
Duration	Minimum pulse duration 100msec.

Signal outputs

Analog output

Function	Transmitting flow rate.
Accuracy	10 bit. Error < 0.05%. Analog output signal can be scaled to any desired range.
Update time	Ten times per second.
Type AA	Active 4 - 20mA output (requires OA + PD, PF or PM).
Type AB	Active 0 - 20mA output (requires OA + PD, PF or PM).
Type AF	Passive floating 4 - 20mA output for Intrinsically Safe applications (requires PC, PL or PD).
Type AI	Passive galvanically isolated 4 - 20mA output - also available for battery powered models (requires PB, PD, PF, PL or PM).
Type AP	passive 4 - 20mA output - not isolated. Unit will be loop powered.
Type AU	Active 0 - 10V DC output (requires OA + PD, PF or PM).

Pulse output

Function	Pulse output - transmitting accumulated total.
Frequency	Max. 64Hz. Pulse length user definable between 7.8 msec up to 2 seconds.
Type OA	One active 24V DC transistor output (PNP); max. 50mA per output (requires AA + PD, PF or PM).
Type OR	One electro-mechanical relay output - isolated; max. switch power 230V AC (N.O.) - 0.5A per relay (requires PF or PM).
Type OT	One passive transistor output (NPN) - not isolated.
Load	Max. 50V DC - 300mA per output.

Communication option

Function	Reading display information, reading / writing all configuration settings.
Protocol	Modbus ASCII / RTU.
Speed	1200 - 2400 - 4800 - 9600 baud.
Addressing	Maximum 255 addresses.
Type CB	RS232
Type CH	RS485 2-wire
Type CI	RS485 4-wire
Type CT	TTL Intrinsically Safe.

Operational

Operator functions

Displayed Functions	<ul style="list-style-type: none"> Flow rate and / or total. Total and accumulated total. Total can be reset to zero by pressing the CLEAR-key twice.
---------------------	----------------------------------------------------------------------------------------------------------------------------------------------------------------------------------------

Total

Digits	7 digits.
Units	L, m ³ , GAL, USGAL, KG, lb, bbl, no unit.
Decimals	0 - 1 - 2 or 3.
Note	Total can be reset to zero.

Accumulated total

Digits	11 digits.
Units / decimals	According to selection for total.
Note	Can not be reset to zero.

Flow rate

Digits	7 digits.
Units	mL, L, m ³ , Gallons, KG, Ton, lb, bl, cf, RND, ft ³ , scf, Nm ³ , NL, igaL - no units.
Decimals	0 - 1 - 2 or 3.
Time units	/sec - /min - /hr - /day.



Display example - 90 x 40mm (3.5" x 1.6")

TOTAL	▲	1742638	m ³
RATE	RUN	1853.9	L/MIN



Ordering information Standard configuration: F110-P-AP-CX-HC-IX-OT-PX-XX-ZX.

Ordering information: F110 _ _ -A_ -C_ -H_ -I_ -O_ -P_ -X_ -Z_



Flowmeter input signal

- A  (o)4 - 20mA input.
- P  **Pulse input: coil, npn, pnp, namur, reed-switch.**
- U  o - 10V DC input.



Analog output signal

- AA Active 4 - 20mA output - requires OA + PD, PF or PM.
- AB Active o - 20mA output - requires OA + PD, PF or PM.
- AF  I.S. floating 4 - 20mA output - requires PC, PL or PD.
- AI Isolated 4 - 20mA output - requires PB, PD, PF, PL or PM.
- AP  **Passive 4 - 20mA output, loop powered unit.**
- AU Active o - 10V DC output - requires OA + PD, PF or PM.





Communication

- CB Communication RS232 - Modbus ASCII / RTU.
- CH Communication RS485 - 2-wire - Modbus ASCII / RTU.
- CI Communication RS485 - 4-wire - Modbus ASCII / RTU.
- CT  Intrinsically Safe TTL - Modbus ASCII / RTU.
- CX  **No communication.**









Panel mount enclosures - IP65 / NEMA4

- HB  Aluminum enclosure.
- HC  **GRP enclosure.**



GRP field / wall mount enclosures - IP67 / NEMA4X

- HD  Cable entry: no holes.
- HE  Cable entry: 2 x 16mm + 1 x 20mm.
- HF  Cable entry: 1 x 22mm (0.866").
- HG  Cable entry: 2 x 20mm.
- HH  Cable entry: 6 x 12mm.

Aluminum field / wall mount enclosures - IP67 / NEMA4X

- HA  Cable entry: 2 x PG9 + 1 x M20.
- HM  Cable entry: 2 x M16 + 1 x M20.
- HN  Cable entry: 1 x M20.
- HO  Cable entry: 2 x M20.
- HP  Cable entry: 6 x M12.
- HT  Cable entry: 1 x 1/2"NPT.
- HU  Cable entry: 3 x 1/2"NPT.
- HZ  Cable entry: no holes.





Inputs

- IB  Terminal input to reset total.
- IX  **No external input.**



Outputs

- OA One active transistor output - requires AA, AB or AU and PD, PF or PM.
- OR One mechanical relay output - requires PF or PM.
- OT  **One passive transistor output - standard configuration.**



Power supply

- PB Lithium battery powered.
- PC  Lithium battery powered - Intrinsically Safe.
- PD  8 - 24V AC/DC + sensor supply - with XI: 16 - 30V DC.
- PF 24V AC/DC + sensor supply.
- PL  Input loop powered from sensor signal type "A" - requires AI or AF and OT.
- PM 115 - 230V AC + sensor supply.
- PX  **Basic power supply 8 - 30V DC (no real sensor supply). Unit requires external loop AP.**

Hazardous area

- XI  Intrinsically Safe.
- XF  EExd enclosure - 3 keys.
- XX **Safe area only.**

Other options

- ZB Backlight.
- ZF  Coil input 10mVpp.
- ZS  Silicone free ABS enclosure with EPDM and PE sealings (type HD only).
- ZX  **No options.**

The bold marked text contains the standard configuration.

 Available Intrinsically Safe.

Specifications are subject to change without notice.

FLUIDWELL bv
P.O. Box 6
5460 AA - Veghel - The Netherlands
Tel.: +31 (0)413 343786
Fax.: +31 (0)413 363443
sales@fluidwell.com
Internet: www.fluidwell.com

